

OG-7010™



USER MANUAL | OG-7010





# Hello.

Congratulations on purchasing your new Ogawa OG-7010.

At Ogawa we understand every body is different and have carefully designed on our massage chair with that in mind. But enough about us, this is about you. Learning how to use your new chair is simple (we designed it that way).

So let's get started.

# TABLE OF CONTENTS

 INTRO	Dimensions .....	3
	Contents .....	4
 CHAIR	Move & Clearance .....	5
	Components .....	6
	Massage Points .....	7
	Specification .....	8
 MASSAGE	Interface .....	9-10
	Pre-Programed Massage .....	11-30
	Pre-Programed Description .....	31-34
 CARE	Safety .....	35-36
	Grounding Instruction .....	37
	Troubleshooting .....	37
	Care and Storage .....	37
	Warranty .....	38

# DIMENSIONS

First, let's get your chair inside.

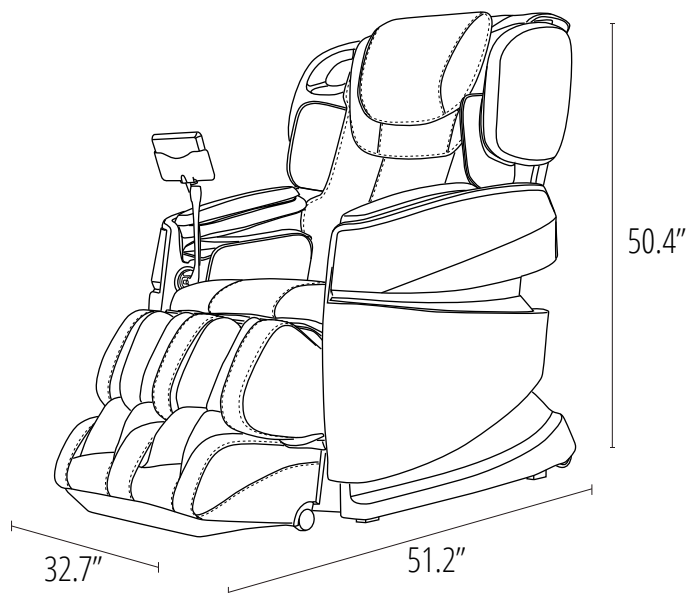

Make sure your door is wider than 36" for the chair to pass through without disassembly

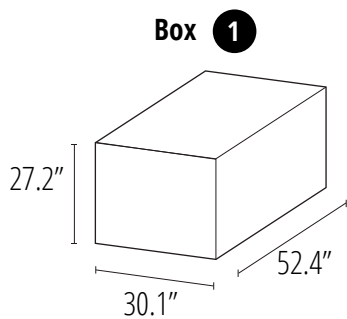

Seat Base

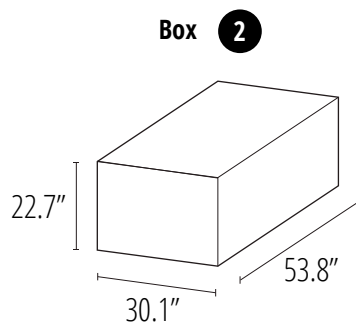

Backrest

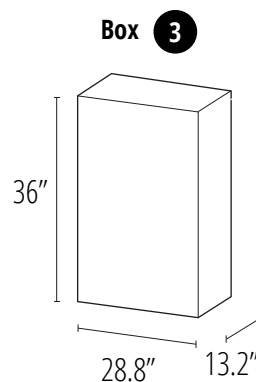

Side Panels

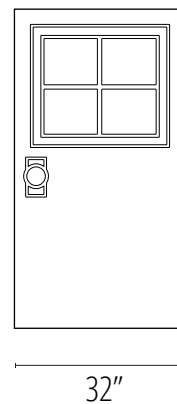

Door width has to be wider than 32"

# CONTENTS

Everything you need for a relaxing experience.

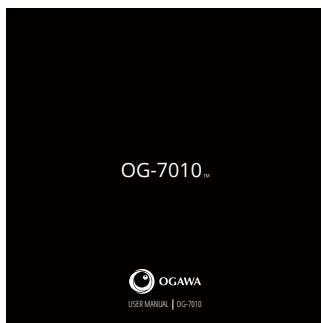

User Manual

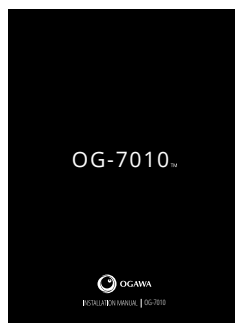

Installation Manual



Warranty Postcard

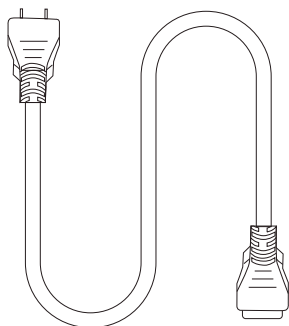

Power Cord

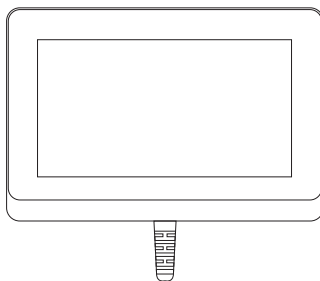

Tablet Remote

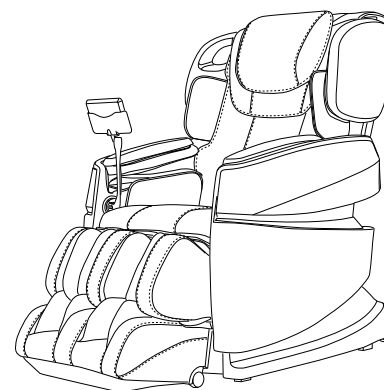

OG-7010 MASSAGE CHAIR

# Move & Clearance

A few simple steps to find the best place for your new chair.

## HOW TO MOVE

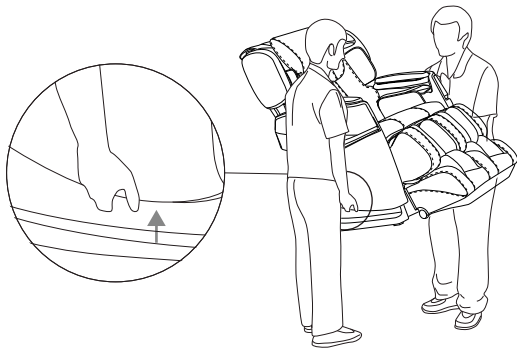

Lift and hold the bottom of the chair

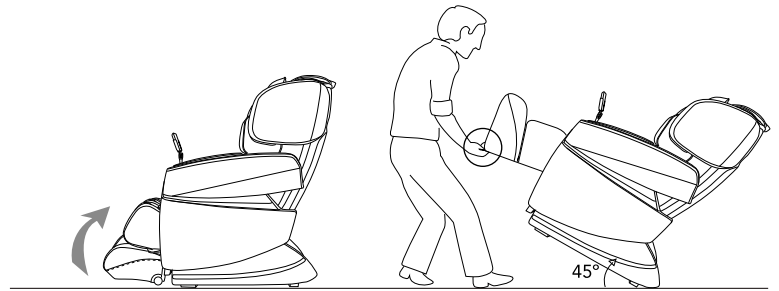

One person lift footrest 45 Degrees onto wheels

## CLEARANCE

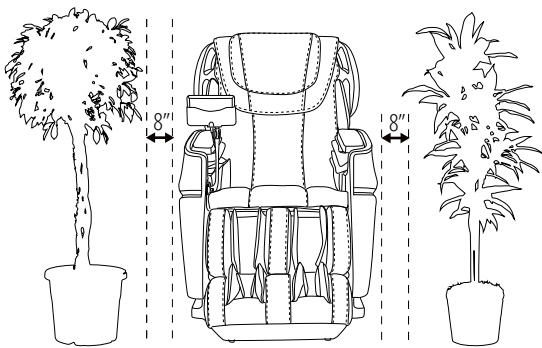

Reserve space on left and right

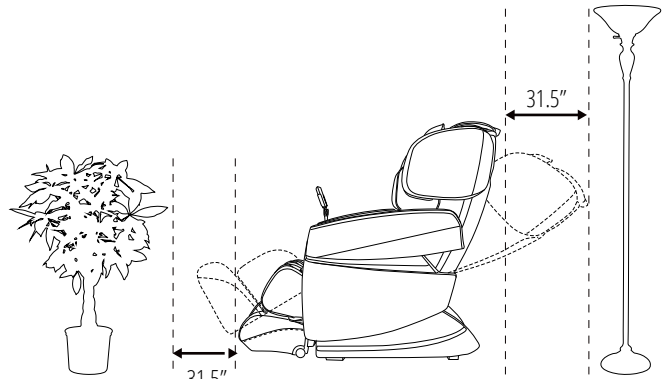

Reserve space in the front and back

# CHAIR COMPONENTS

Some of your chair's most important features.

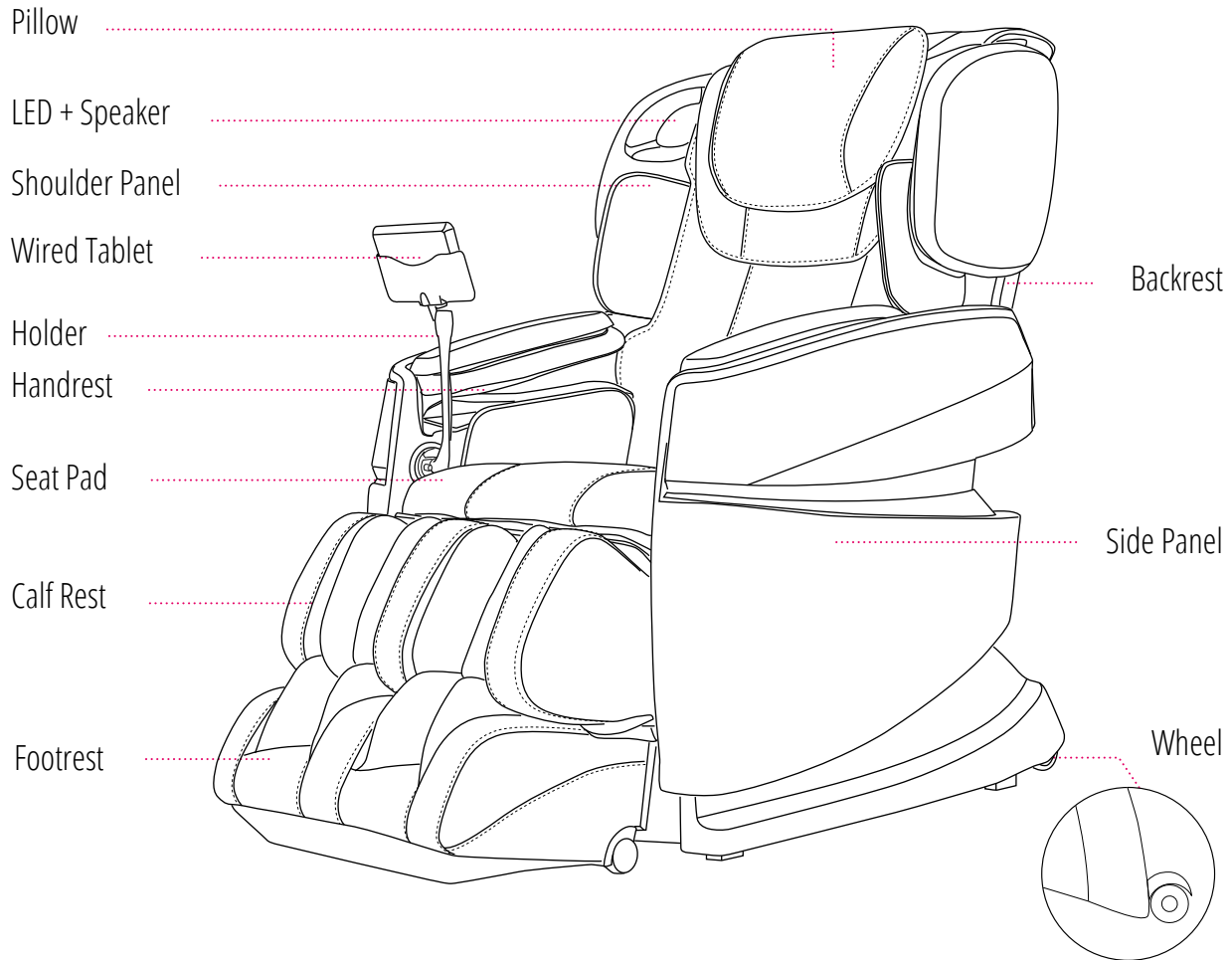

Note: The speaker will only operate when the massage chair is in operation



To play music using your massage chair's speakers please connect your smartphone, tablet, or other electronic device to your chair using bluetooth

# MASSAGE POINTS

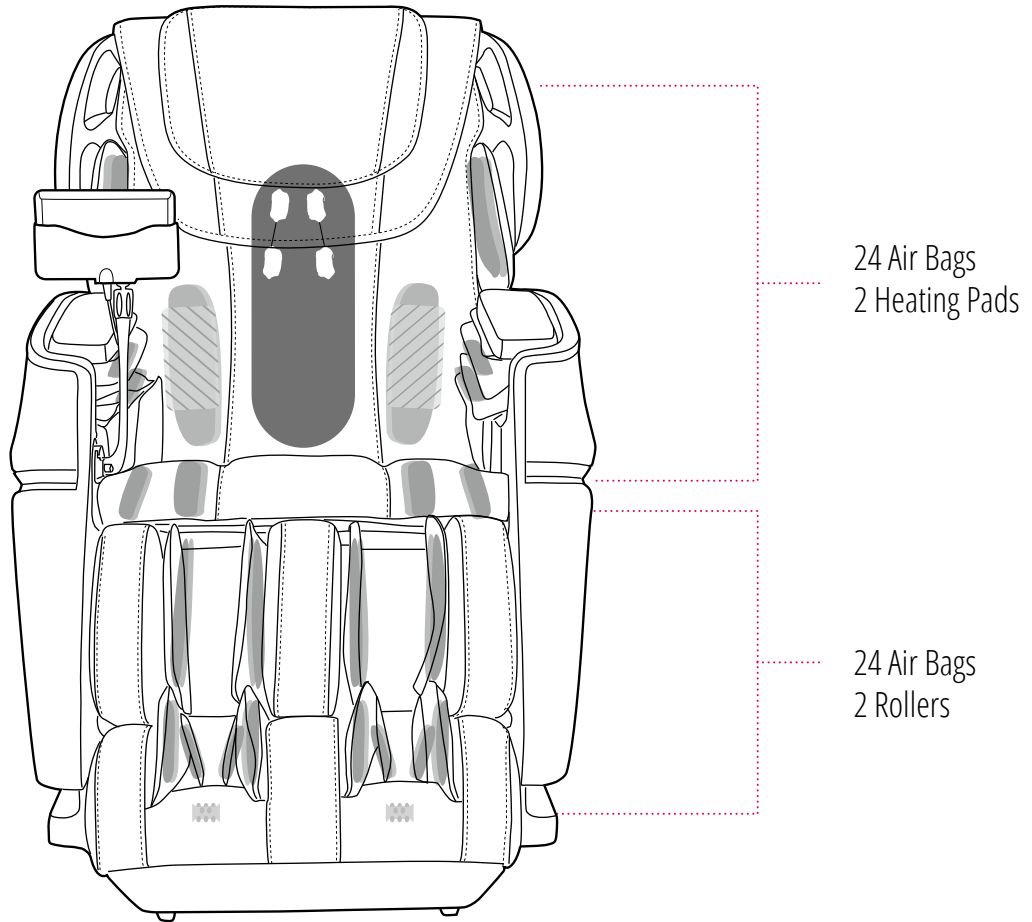



# CHAIR SPECIFICATIONS

A few important facts about your massage chair.



**Model No.**  
OG-7010

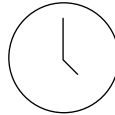

**Max. Time Rate**  
30 minutes

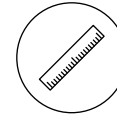

**Dimensions (L x W x H)**  
Chair Dimension: 51.2" x 32.7" x 50.4"  
Reclined Dimension: 72.8" x 32.7" x 40.6"



**Shipping Weight**  
Gross weight: 310.2 lbs  
Net Weight: 250.8 lbs

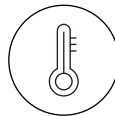

**Usage Condition**  
Environment temperature: 10°C-40°C  
Contrasting humidity: 30-85RH

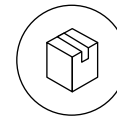

**Storage Condition**  
Storage temperature: -20°C-60°C  
Storage humidity level: 30-85RH

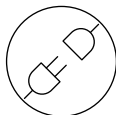

**Power Consumption**  
120W



**Rated Voltage**  
110 - 120V



**Rated Frequency**  
60Hz



**Power of Speakers**  
2 x 7W (2 sides)

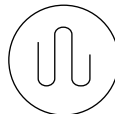

**Length of Wiring**  
Controller wiring 59.1"  
Power supply wiring 70.9"



**Safety Feature**  
Equipped with overheating and power surge detectors safety feature

# WIRED TABLET INTERFACE

We have designed your massage chair's tablet controller with a user-friendly interface to make using your chair even easier.

## Home Screen

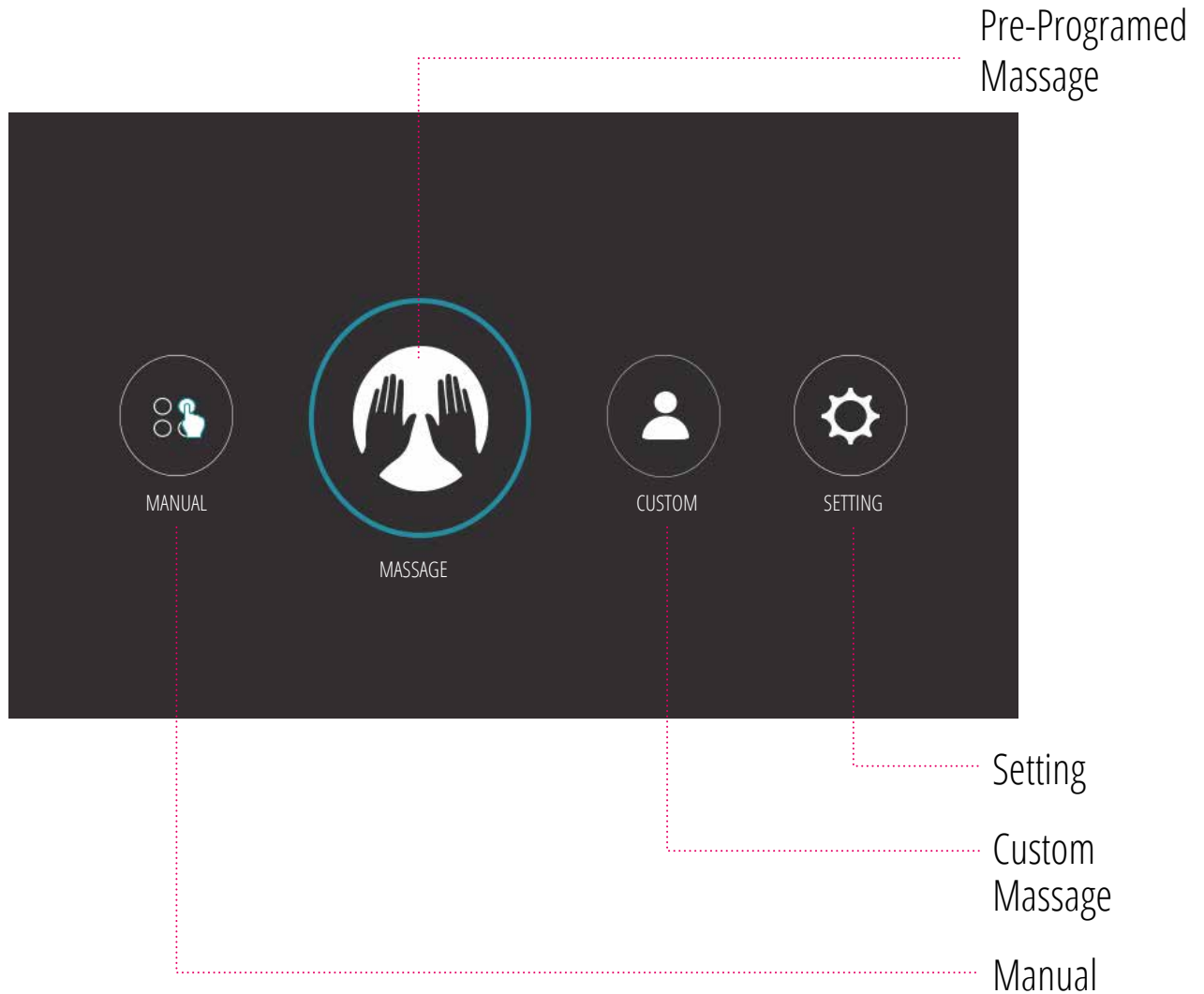

## Massage Controls

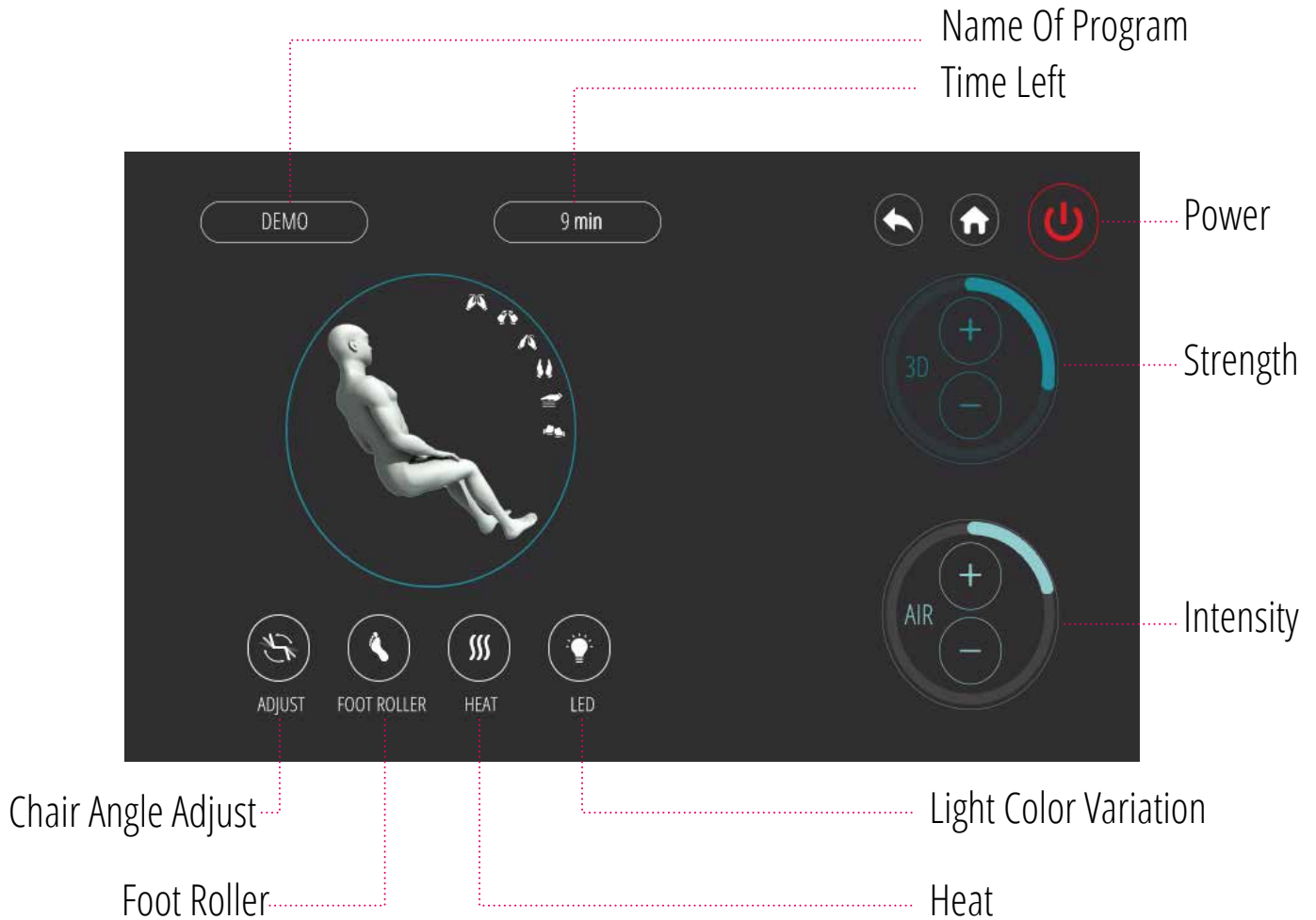

# PRE-PROGRAMMED MESSAGE

We have designed your chair with multiple massage options for your changing needs. Follow these simple instructions to begin a new pre-programmed massage.

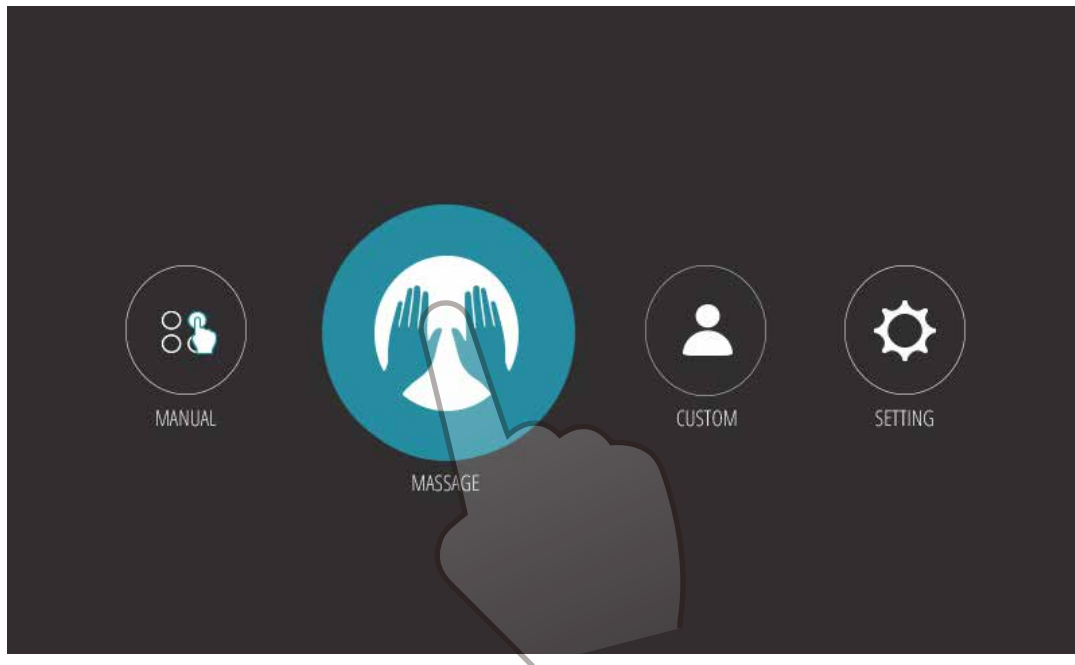

Choose the "Message" icon to select your pre-programmed massage



Choose 1 of our 11 pre-programmed massages

## Pre-Programmed Massage Interface

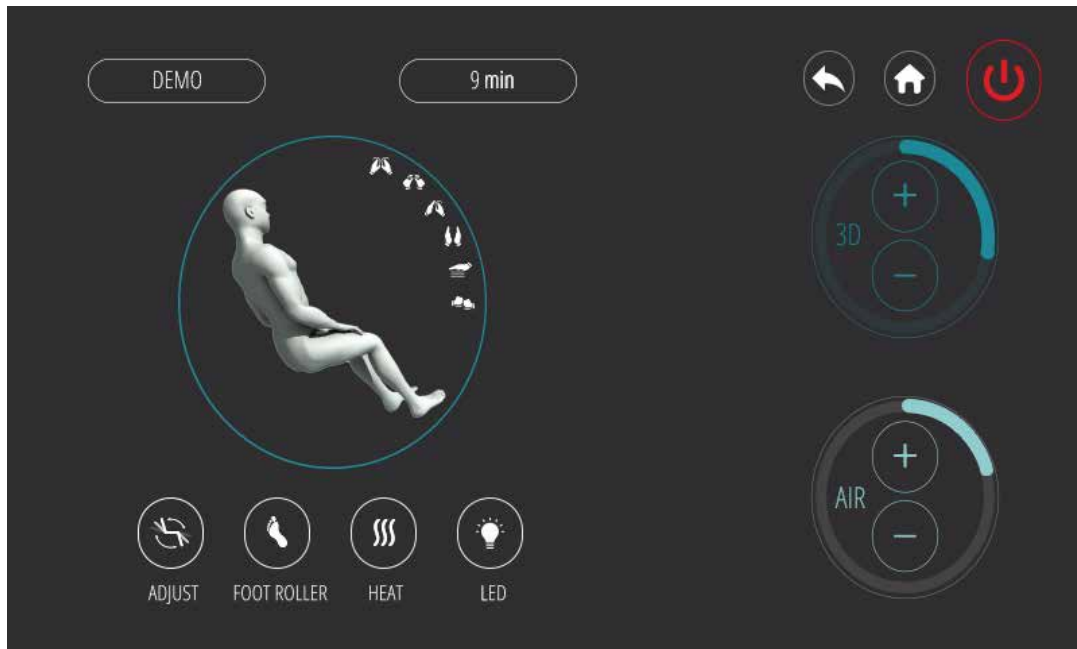

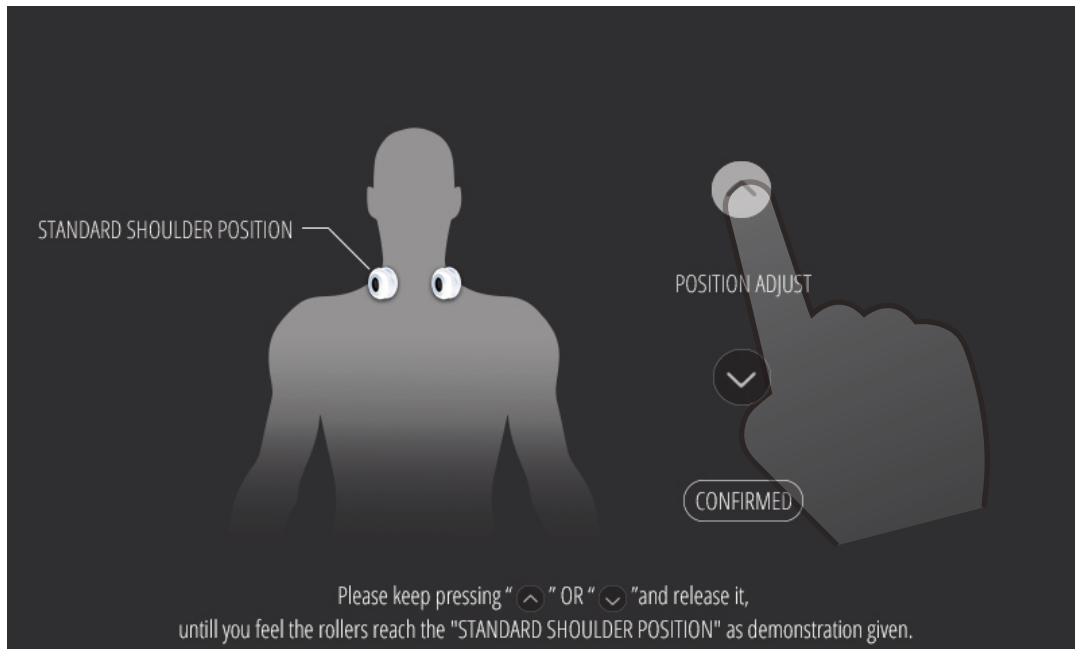

Using the arrows, you can adjust the standard shoulder position

## Adjust Chair Angle Interface



Fast adjust chair angle by ZERO GRAVITY 1, ZERO GRAVITY 2, and HOME buttons



# MANUAL

You can choose manual massage action and compression in this program.

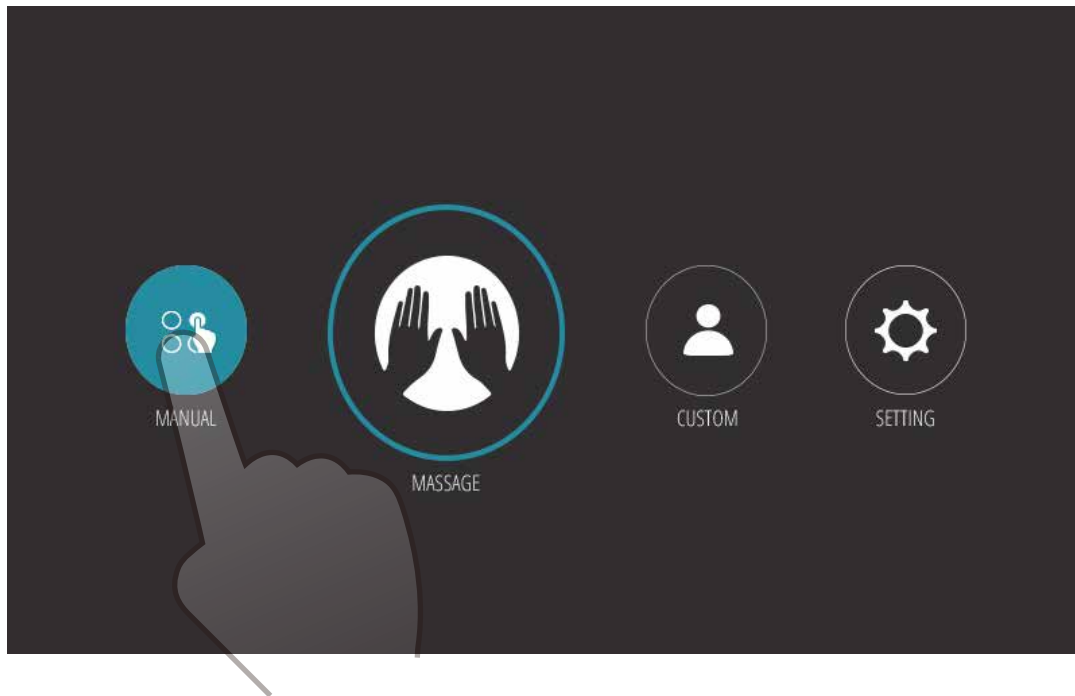

Choose the "Manual" icon to begin manual massage

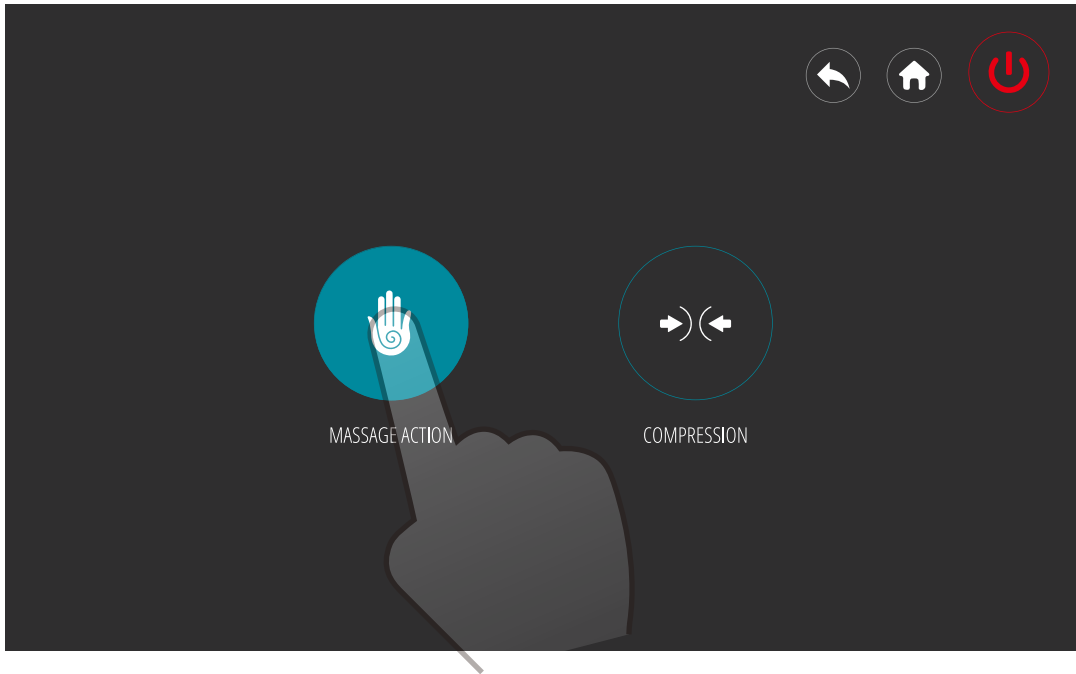

Choose the "Message Action" icon

## Massage Action Interface

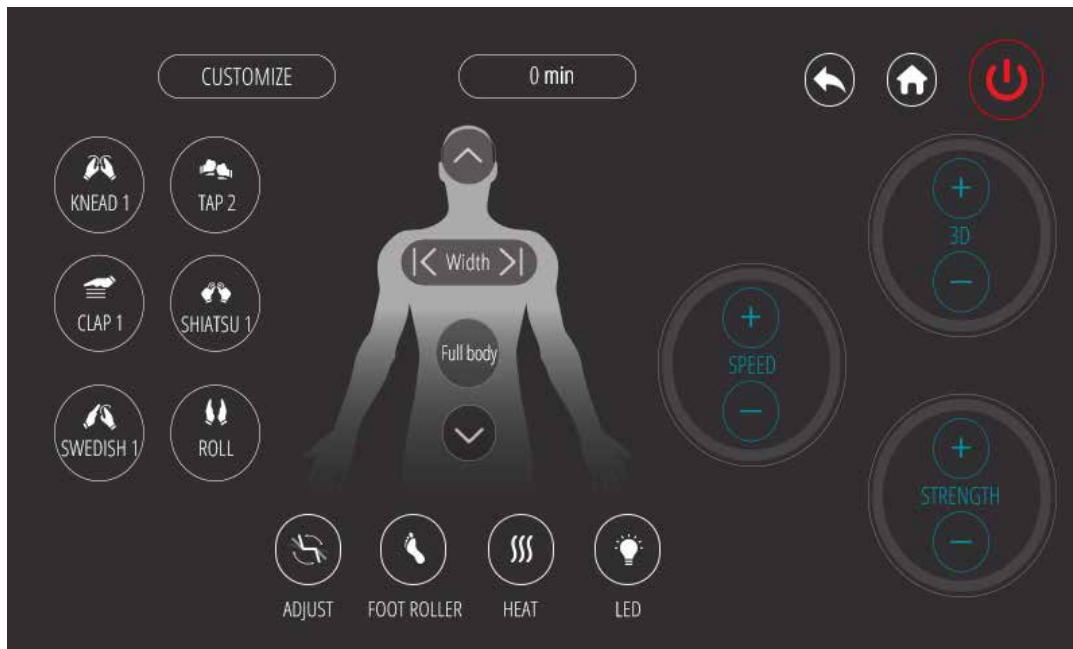

The knead, tap, clap, and shiatsu massages can be combined with swedish or roll

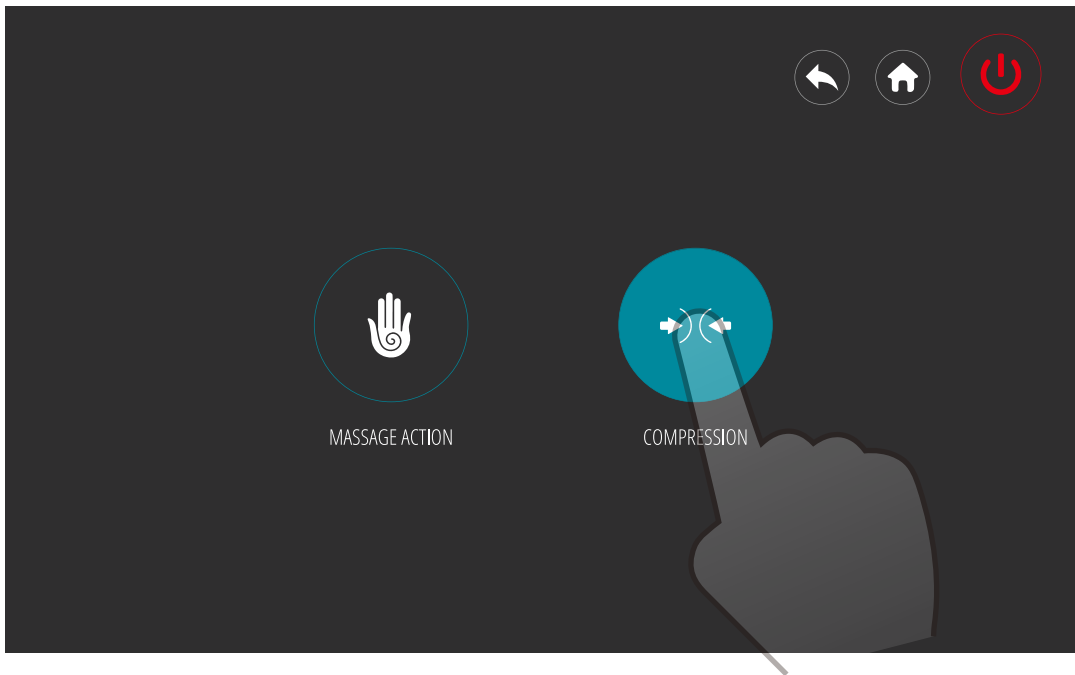

Choose the "Compression" button

## Compression Interface

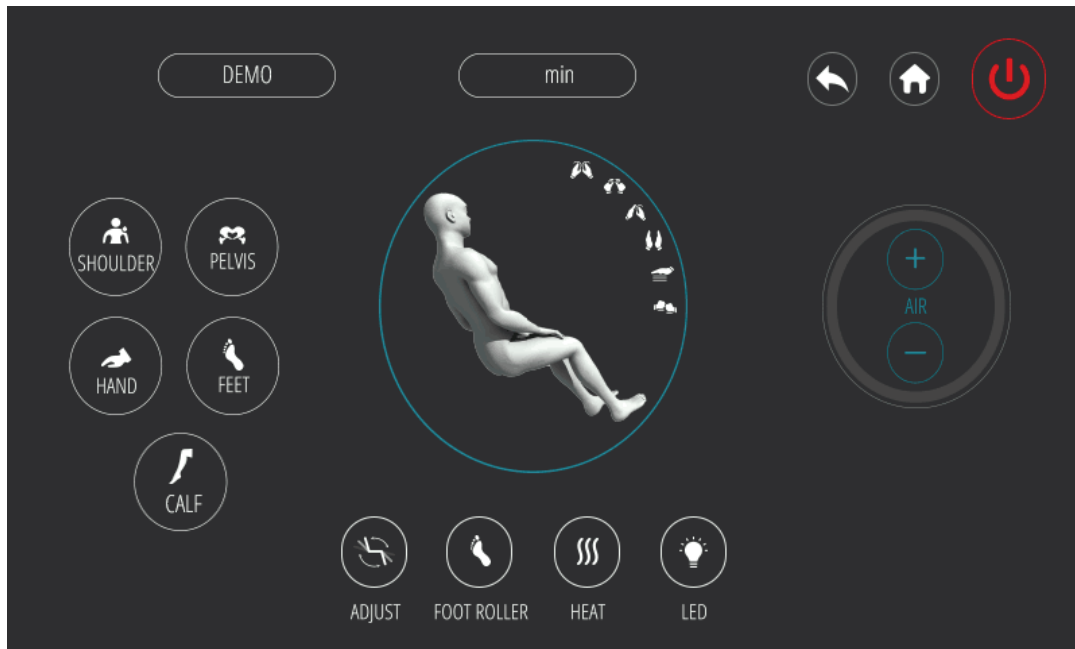

# CUSTOM MESSAGE

Every body is different. That's why we've given you the option to customize your own message to meet your specific needs. Follow these simple instructions to create a new custom message. You can create up to 3 custom programs. To delete a custom message, press and hold the custom icon and press "delete".

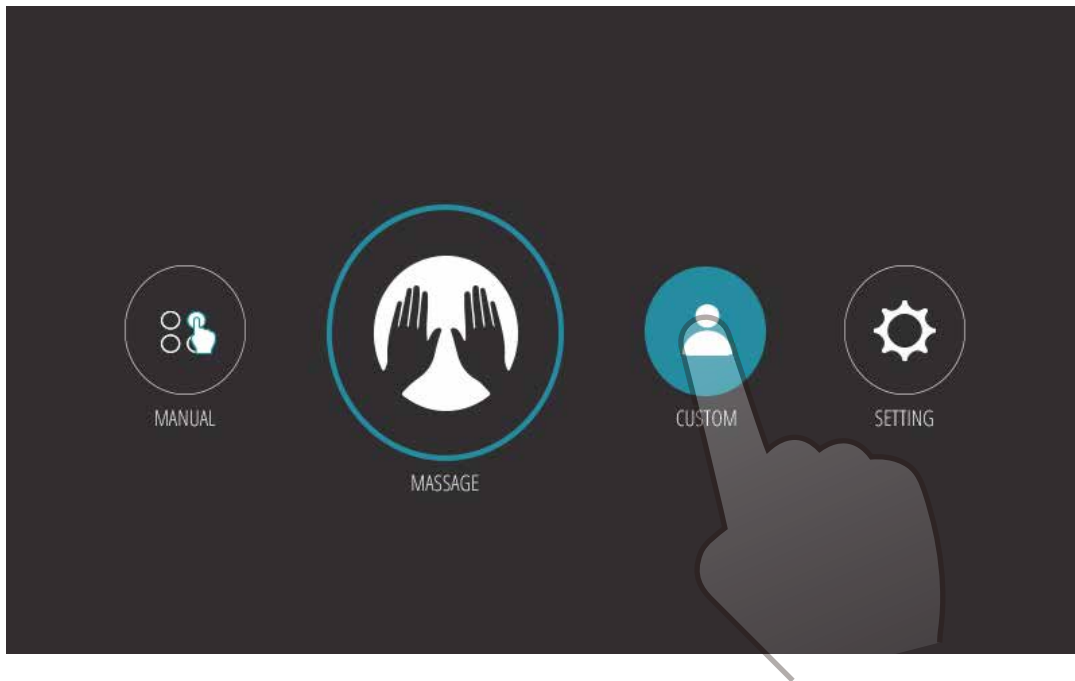

Choose the "Custom" icon to begin creating your message program

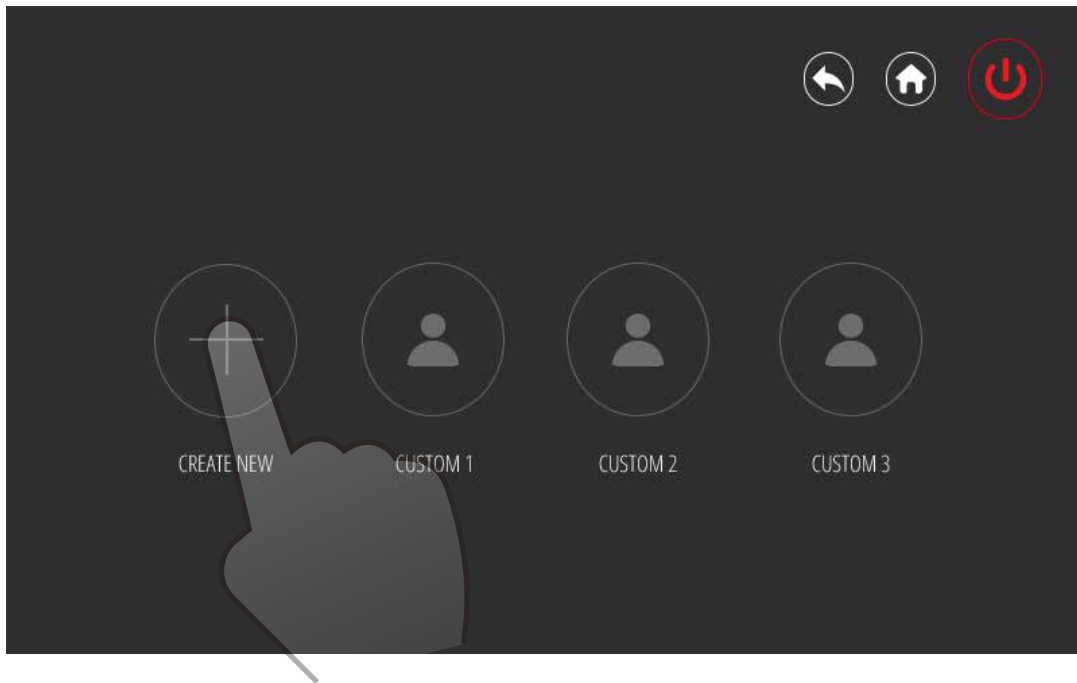

Choose the "Create New" icon

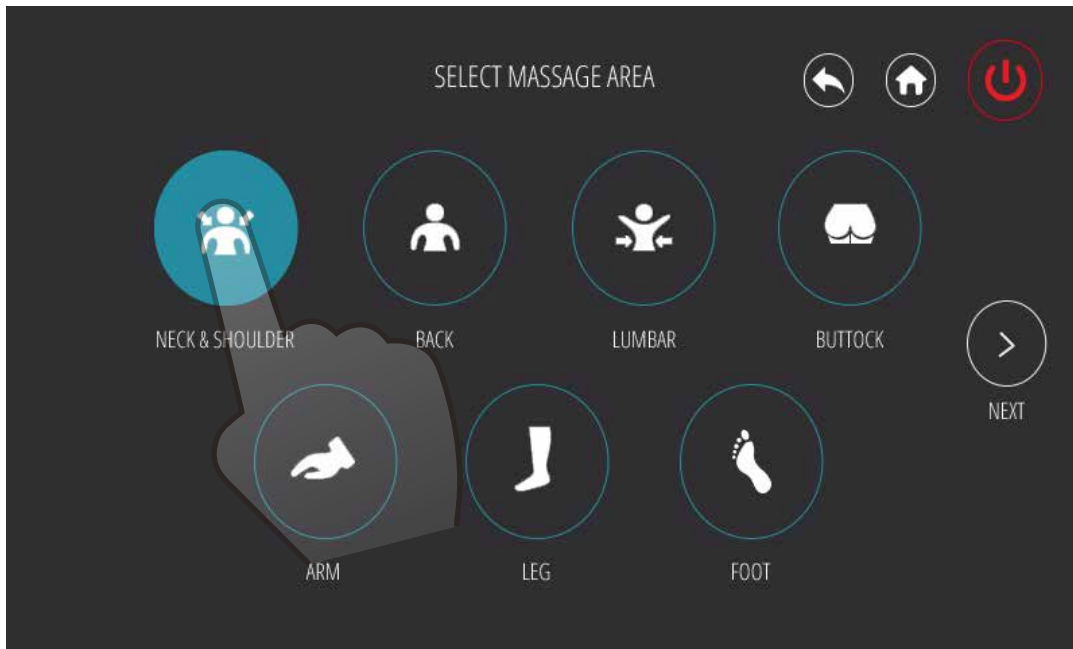

Select your massage area





Select your favorite massage actions. The knead, tap, clap, and shiatsu massages can be combined with swedish or roll

# SETTINGS

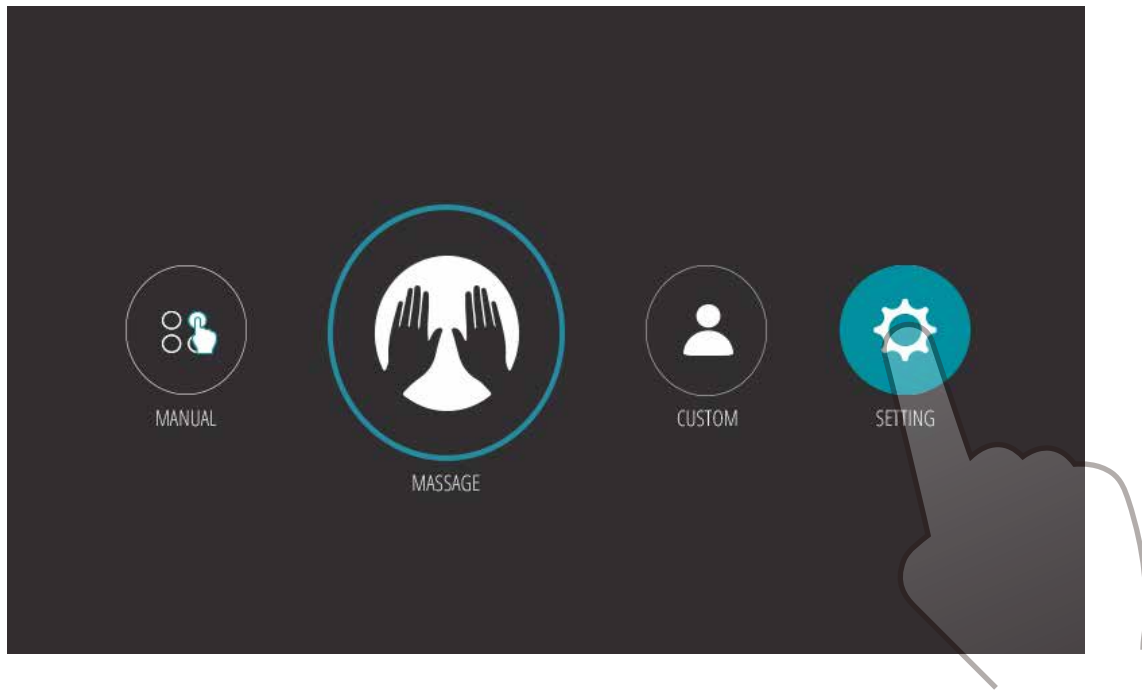

Choose the “Setting” button to take you to the settings page

## Settings Interface

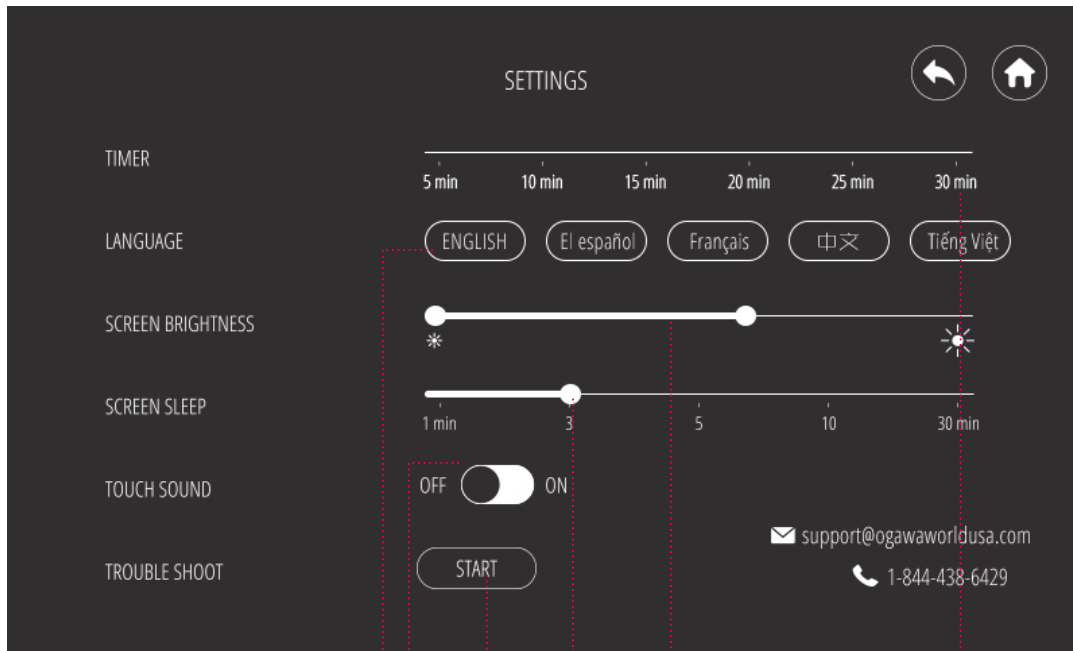

Language Adjust

Touch Sound Adjust

Trouble Shoot Detecting Button

Timer Adjust

Screen Brightness Adjust

Screen Sleep Time Adjust

## Trouble Shooting



If your chair has any trouble, press the Trouble Shoot "Start" button for the chair to automatically detect problem areas, and then you can use this information when you contact our customer service team

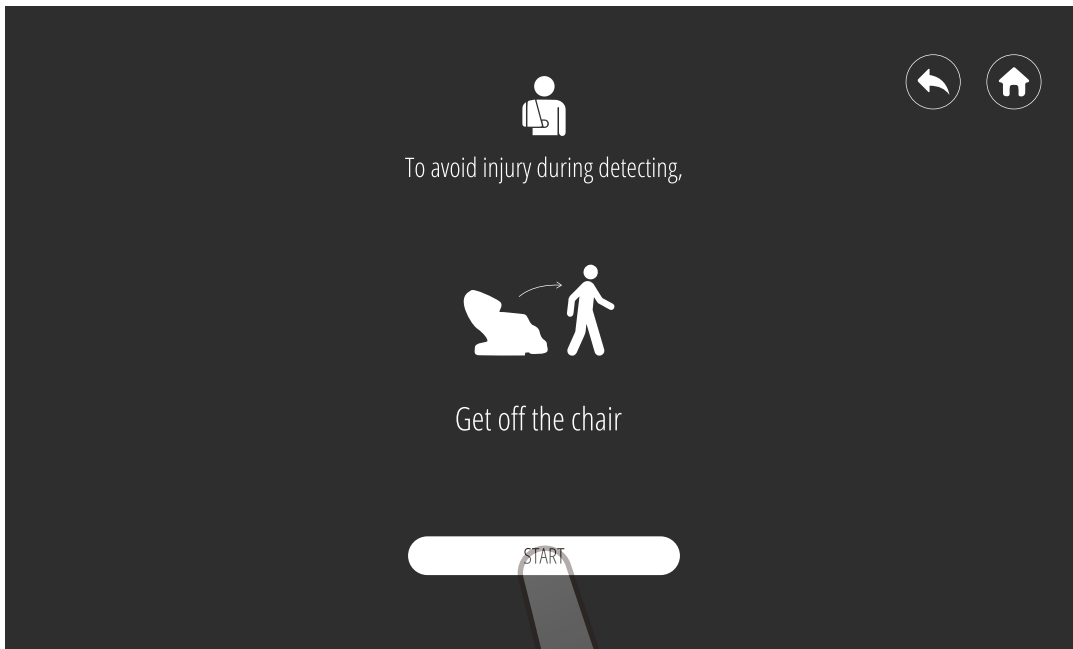

Choose "Start" button and make sure the chair is not occupied during chair detection

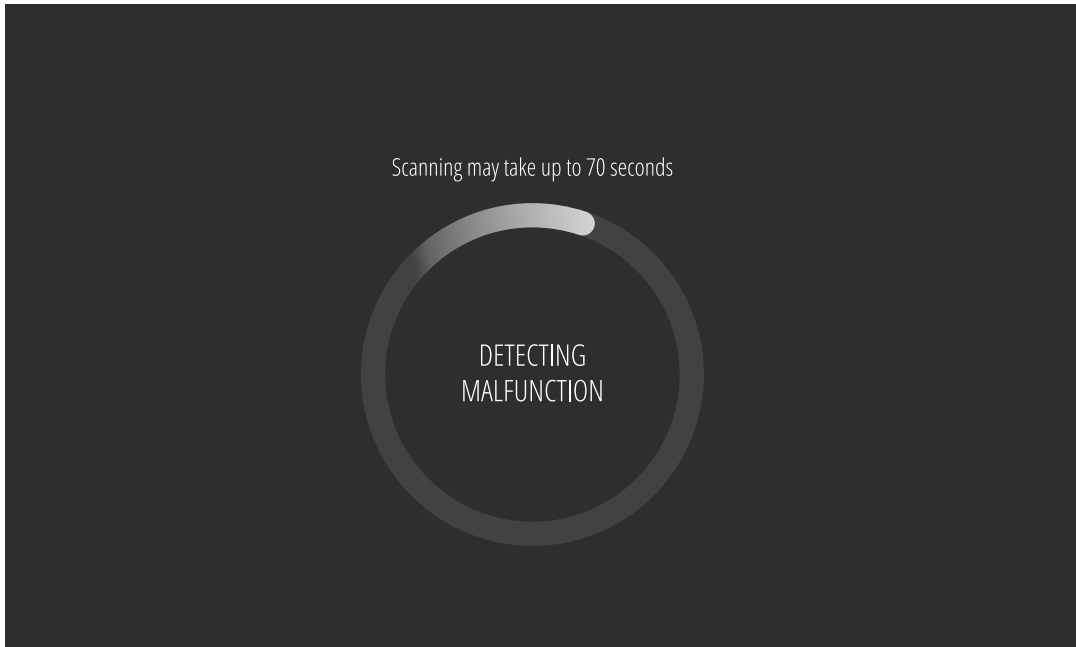

Your chair is detecting possible malfunctions, please wait for the detection result

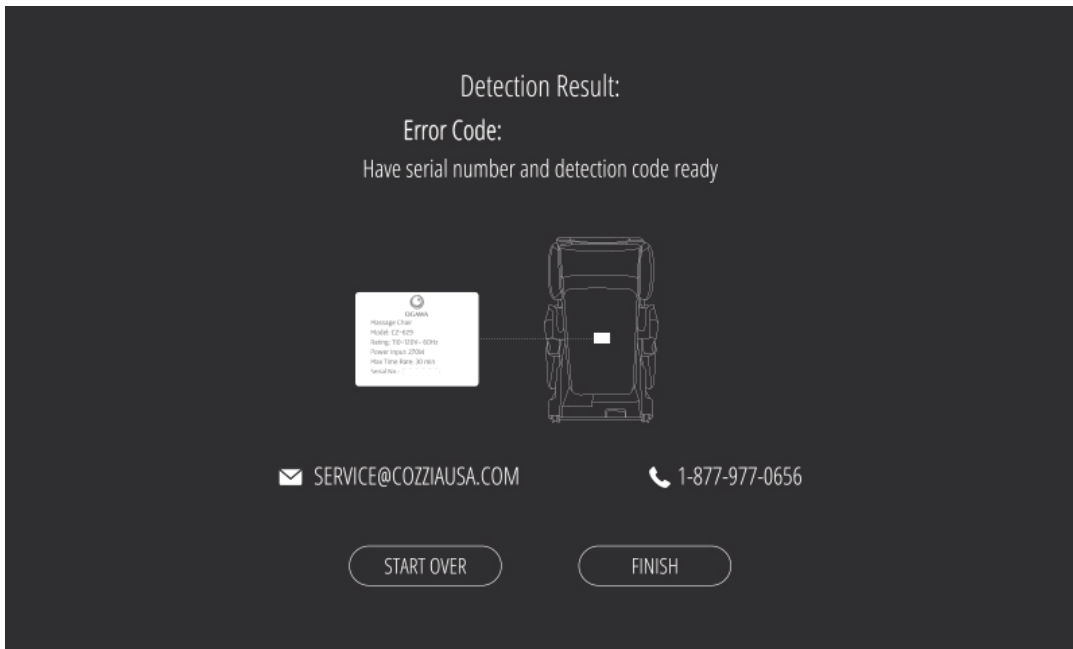

You can use your detection code when contacting the Ogawa customer team about your chair's problems

# PRE-PROGRAMED DESCRIPTION

Let's dig a little deeper and discover the details of our pre-programed massages.

## DEMO



A 5 minute whole body massage for those on the go.

## FOCUS AREA

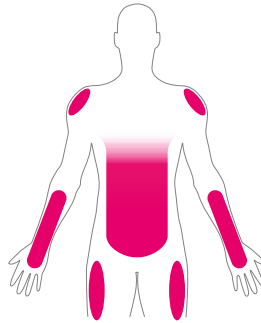

## INTENSITY



## FOCUS TECHNIQUE



KNEAD



ROLL

## GENTLE



A program designed to provide a quiet, gentle massage that is good for beginners or those that prefer a soft touch.

## FOCUS AREA

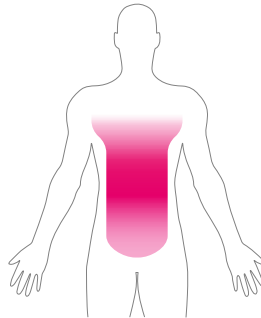

## INTENSITY



## FOCUS TECHNIQUE



KNEAD



TAP

## RELAX

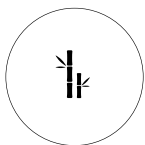

A program designed to provide a mild massage that is great for deep relaxation, best used before going to sleep.

## FOCUS AREA

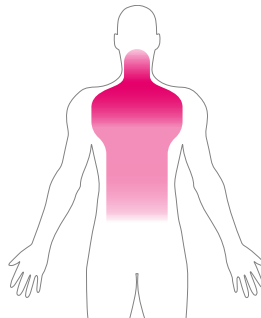

## INTENSITY



## FOCUS TECHNIQUE



SHIATSU



SWEDISH



## THERAPY



A program designed to provide a soothing massage combined with air massage on shoulder and glutes.

## FOCUS AREA

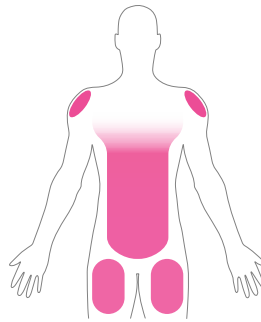

## INTENSITY



## FOCUS TECHNIQUE



KNEAD



CLAP

## VIGOROUS



A program designed for those who enjoy a strong deep tissue massage and provides a boost of energy for users.

## FOCUS AREA

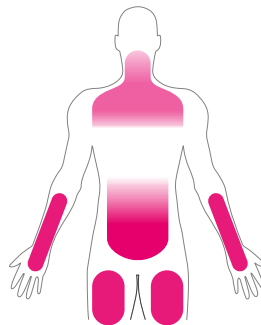

## INTENSITY



## FOCUS TECHNIQUE



KNEAD



TAP

## SWEDISH



A program designed to use Swedish techniques to promote blood circulation to the heart, increasing oxygen in the blood and easing tension.

## FOCUS AREA

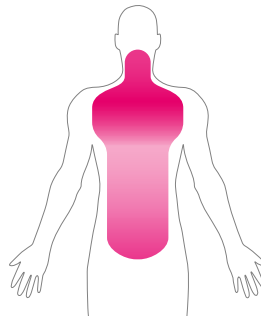

## INTENSITY



## FOCUS TECHNIQUE



CLAP



SWEDISH

## JAPANESE



This massage will focus on your midback and upper shoulders with a deep tissue massage using the shiatsu technique that will create an acupuncture effect.

### FOCUS AREA

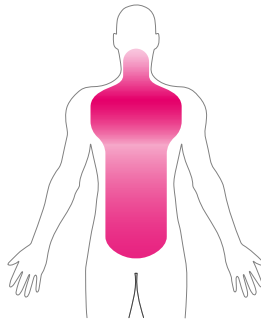

### INTENSITY



### FOCUS TECHNIQUE



SHIATSU



SWEDISH

## FULL BODY STRETCH



This program provides you with a full body stretch, including your arm, leg, and shoulder muscles

### FOCUS AREA

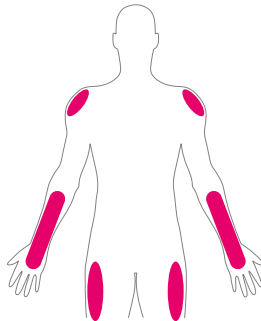

### INTENSITY



### FOCUS TECHNIQUE



KNEAD



ROLL

## LOWER BODY STRETCH



This program provides you with a lower body stretch, focusing on your leg muscles

### FOCUS AREA

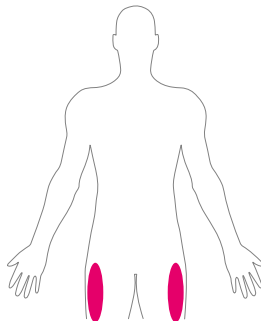

### INTENSITY



### FOCUS TECHNIQUE



KNEAD



ROLL

## UPPER BODY STRETCH



This program provides you with an upper body stretch, focusing on your shoulder and back muscles

### FOCUS AREA

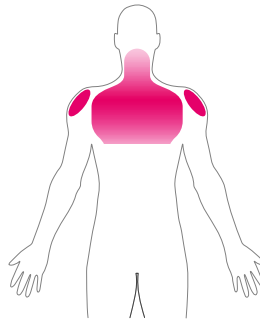

### INTENSITY



### FOCUS TECHNIQUE



KNEAD



ROLL

## HIP AND WAIST STRETCH



This program provides you with a hip and waist stretch, focusing on your hip and waist muscles

### FOCUS AREA

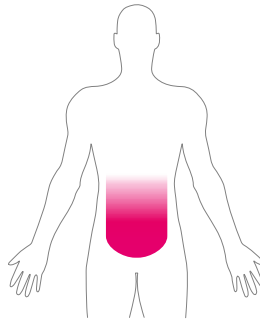

### INTENSITY



### FOCUS TECHNIQUE



KNEAD



ROLL

# SAFETY PRECAUTIONS

We're looking out for you.

## IMPORTANT SAFETY INSTRUCTIONS

When using an electrical appliance, basic precautions should always be followed, including the following: Read all instructions before using (this appliance).

**DANGER**—To reduce the risk of electric shock:

- Always unplug this appliance from the electrical outlet immediately after using and before cleaning.
- Never use pins or other metallic fasteners with this appliance.
- Carefully examine the covering before each use. Discard the appliance if the covering shows any sign of deterioration, such as checking, blistering, or cracking.

**WARNING**—To reduce the risks of burns, fire, electric shock or injury to persons:

- An appliance should never be left unattended when plugged in. Unplug from outlet when not in use, and before putting on or taking off parts.
- Close supervision is necessary when this appliance is used by, on, or near children, invalids, or disabled persons.
- Use this appliance only for its intended use as described in this manual. Do not use attachments not recommended by the manufacturer.
- Never operate this appliance if it has a damaged cord or plug, if it is not working properly, if it has been dropped or damaged, or dropped into water. Return the appliance to a service center for examination and repair.
- Do not carry this appliance by supply cord or use cord as a handle.
- Keep the cord away from heated surfaces.
- Never operate the appliance with the air openings blocked. Keep the air openings free of lint, hair, and the like.
- Never drop or insert any object into any opening.
- Do not use outdoors.
- Do not operate where aerosol (spray) products are being used or where oxygen is being administered.
- To disconnect, turn all controls to the off position, then remove plug from outlet.
- Keep children away from extended foot support.
- Connect this appliance to a properly grounded outlet only. See Grounding Instructions.
- Use heated surfaces carefully. May cause serious burns. Do not use over insensitve skin areas or in the presence of poor circulation. The unattended use of heat by children or incapacitated persons may be dangerous.
- Do not operate under blanket or pillow. Excessive heating can occur and cause fire, electric shock, or injury to persons.

## SAVE THESE INSTRUCTIONS

This massage chair is intended for household use only.

### 1. Usage Environment

- Do not use the massage chair in an excessively humid or dusty environment as this may result in malfunction or electric shock.
- Do not use the massage chair in a room with a temperature of 104°F or higher.
- Do not expose the massage chair to heaters, stoves or direct sunlight.
- Place and use the massage chair on an even, non-slip floor.
- The massage chair is designed for home use and not for commercial purposes.



Caution

- This massage chair is to be used indoors only.
- If you use the massage chair in a cold room, do not increase the room temperature abruptly. It is recommended that you increase the temperature gradually to a normal level.
- If the massage chair is stored in a cold place and is being brought into a warm environment, it is advisable to wait for one hour before use. This is because its performance may not be at optimum level, as there may be water droplets on the mechanical parts due to consideration. Using the massage chair under such conditions may result in malfunction.

### 2. Safety Precautions

- To ensure safe and correct use of the massage chair, do not operate it without reading this operation manual carefully.
- Do not use the massage chair when the upholstery or seat is removed. This may cause injury or malfunction.
- Do not use the massage chair in combination with other therapeutic equipment or electric blanket etc., as this may result in ineffectiveness or injury.
- Do not use the massage chair an hour before or after eating as this may have adverse effects on the user.
- Do not allow children or pets to play around the massage chair, e.g. behind the backrest, under the seat base or legrest of the massage chair. This may result in injury.
- Do not use the massage chair when your body is wet.
- Do not operate the massage chair with wet hands.
- It is not recommended to use the massage chair for more than 30 minutes.
- Do not perform continuous massage on the same spot of your body for more than 5 minutes at a time as this may result in excessive stimulation and may have adverse effects.
- Do not insert your hand or foot along the paths of the massage rollers during use as this may cause injury.
- Stop operation immediately if you feel any discomfort.
- This product is not intended for self-treatment of conditions that should be managed by a qualified health care provider.
- People on medication or with medical conditions, please consult your doctor before use. Please do not use the product if you are not feeling well.

### 3. People with Medical Conditions

Consult your doctor before use if you:

- are under medical rest as ordered by a doctor.
- have spinal disorders, an abnormal spinal condition or have suffered a spinal injury.
- have back problems.
- have diabetes, osteoporosis or sensory impairment.
- have joint dysfunction such as rheumatism, hammertoe or gout.
- have a pacemaker or other electronic medical devices.
- may be pregnant.
- have phlebitis or thrombosis.
- have an increased risk for blood clots.
- had recent surgery.
- Have surgical pins, screws, or anything mechanical in the legs, ankles or feet.



#### Caution

- This massage chair is not intended for use by children or persons with reduced physical, sensory or mental capabilities, or lack of experience and knowledge, unless they have been given supervision or instruction or instruction concerning use of the massage chair by a person responsible for their safety.
- Children should be supervised to ensure that they do not play with the massage chair.
- Avoid using the massage chair under the influence of alcohol.
- Do not apply massage rollers directly on the head, elbow or knee joints, torso or abdomen.
- If your legs or feet slip off the leg rest during massage, do not force them back in as this may result in injury.
- Remove the power plug from the electrical outlet immediately should liquid be accidentally spilled onto the massage chair. Do not use wet hands to connect or disconnect the power plug from the electrical outlet.
- Do not tamper with the power cord or use the massage with a damaged cord as this may result in malfunction and electric shock.

### 4. Instances When the Massage Chair Should Not Be Used

In the following events, please switch off the main power switch immediately and disconnect the power cord from the electrical outlet:

- If **liquid** is accidentally spilled onto the massage chair. This may result in electric shock or malfunction.
- If the fabric of the backrest is torn and the internal components are exposed.
- If pain or discomfort is felt during massage, stop operation immediately and consult your doctor.
- If you detect any malfunction or any other abnormal condition during operation.
- If there is power failure. Injury may occur when power is restored unexpectedly.
- If there is lightning.

### 5. Assembly and Repair of the Massage Chair

- Do not disassemble the backrest cover of the massage chair. Touching the internal components may result in malfunction or electrical shock.
- This massage chair must only be professionally serviced or repaired. Do not attempt to disassemble or repair the massage chair by yourself.

### 6. Things to Be Noted About the Power Plug and Cord

- Check that the Alternating Current (AC) voltage corresponds with the specifications indicated for the massage chair.
- Do not connect or disconnect the power plug from the electrical outlet with wet hands. This may result in malfunction or electric shock.
- When disconnecting the power plug, pull it by holding the plug, not the cord.
- Although operation will be stopped automatically by the Auto-Timer function, always remember to switch off the main power after use.
- Do not place the power cord under the massage chair or any other heavy objects.
- Do not wind the power cord around the massage chair as this may damage the cord and result in a fire or electric shock.
- Do not operate the massage with a damaged cord or extension cord.
- Do not use the massage if the electrical outlet is loose.
- If the power cord is damaged, it should be replaced by a qualified technician.

# GROUNDING INSTRUCTIONS

This product must be grounded. If it should malfunction or break down, grounding provides a path of least resistance for the electric current to reduce the risk of electric shock. This product is equipped with a cord with an equipment-grounding conductor and a grounding plug. The plug must be plugged into an appropriate outlet that is properly installed and grounded in accordance with all local codes and ordinances.

**Danger-**Improper connection of the equipment-grounding conductor can result in a risk of electric shock. Check with a qualified electrician or serviceman if you are in doubt as to whether the product is properly grounded. Do not modify the plug provided with the product – if it will not fit the outlet, have a proper outlet installed by a qualified electrician.

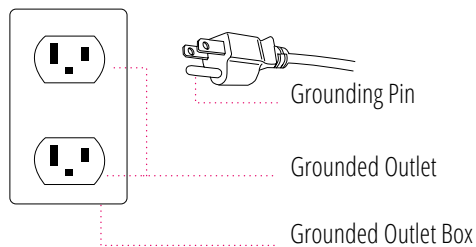

# TROUBLESHOOTING

This massage chair is controlled by a microcomputer and is thus susceptible to power surges of +10 to-15%. The following situations may arise in the event of a power surge:

Situation	Solution
The massage chair is connected to the power supply but is not functioning	1. Check to see that the plug is properly connected and working 2. Ensure the massage chair switch is in the 'I' position
The remote control works but the massage chair is not functioning.	Possible overheating due to prolonged use. Turn off the power for at least 30 to 50 minutes
Both the remote control and the massage chair are not functioning	1. Ensure the chair is plugged into a working outlet 2. Turn the power OFF and ON again

If you continue to have problems, please read the warranty card and contact the Ogawa service department.

# PRODUCT CARE AND STORAGE

## 1. Storing the Massage Chair

- Wipe off dust and dirt from the massage chair with a dry, soft, clean cloth after use.
- Keep the massage chair clean and away from places of high humidity.
- If the massage is not to be used for a long period of time, cover the massage chair with a dust cover and unplug its power plug from the electrical outlet.

### ⚠ Caution

- Do not store the massage chair in direct sunlight or in places of high temperature. This may cause the color of the upholstery to fade.
- Do not allow the massage chair to remain in contact with vinyl or wallpaper for extended periods of time as this could lead to discoloration.

## 2. Cleaning the Massage Chair

- Before cleaning, ensure that the main power switch is off and the power plug is disconnected from the electrical outlet.
- Wipe off dust and dirt from the massage with a dry, soft, clean cloth after each use.
- This product can be cleaned thoroughly with a slightly damp cloth.
- Do not iron the upholstery.
- Do not wash the upholstery using a home washing machine as this may result in deterioration of the upholstery's quality.

### ⚠ Caution

- Do not use abrasive cleaning agents like benzene or thinner to clean the massage chair. This may cause the upholstery to fade.

## 3. Cleaning the Controller

- Use only a clean, dry cloth to clean the controller.

### ⚠ Caution

- Do not use a wet cloth to clean the controller. This may result in malfunction.

# OGAWA CONSUMER WARRANTY

OGAWA products have the following warranty:

OGAWA's massage chairs, motion upholstery and home theater massage seating provide a one year in-home service warranty and a two-year parts warranty. OGAWA customer service will not issue Return Material Authorizations (RMAs) for products. OGAWA products will be either repaired by the consumer or by an in-home technician. OGAWA will not issue Return Material Authorizations (RMAs) for buyer's remorse.

## Service And Technical Support

Consumers may contact OGAWA's customer service department at 844-438-6429 between 9:00 am and 5:00 pm PST, Monday through Friday or email us at [support@ogawaworldusa.com](mailto:support@ogawaworldusa.com) or visit our web at [www.ogawaworldusa.com](http://www.ogawaworldusa.com) for warranty or service issues.

Consumers are required to provide the unit serial number and dated proof of purchase (sales receipt) when they contact the OGAWA service department regarding a repair.

A OGAWA customer service representative will attend to most consumer inquiries, but in some cases a technical service specialist will provide advanced support.

Non-warranty repair is provided on a "per incident" basis. OGAWA customer service will verify that the unit has failed and provide instructions for repairing a unit. All applicable repairs, parts, shipping, handling, local tax and a "per incident" fee will be charged for non-warranty repairs and support calls.

Proof of purchase (original receipt) is required for all warranty repairs or service.

## Extended Warranties:

Ogawa offers extended warranty programs to enhance ownership of Ogawa product. Extended warranty provides: 3-year limited repair or replacement massage chair warranty with on-site service. Please visit [www.ogawaworldusa.com](http://www.ogawaworldusa.com) for the latest terms and pricing for extended warranties.

## Product Repairs

Many OGAWA product repairs may be performed by the consumer in their own home with parts and instructions supplied by OGAWA such as remote controller replacements that don't require a technician. Canadian consumers may contact OGAWA's customer service department at 844-438-6429 between 9:00 am and 5:00 pm PST, Monday through Friday for warranty or service issues.

- Floor Models and Demonstration Units have a prorated warranty period that begins the day the model is placed on the floor and connected to an electrical outlet by the retail partner. Proof of purchase is required in order to obtain warranty service and parts. Non-warranty parts and service are available at a "per incident" charge.

- Warranty Coverage Period - Warranty coverage starts at the time that the consumer PURCHASES their chair. Proof of purchase is required for all warranty repairs. The warranty time period is measured by continuous calendar days based on a seven-day week.
- Field Service – OGAWA customer service department will diagnose and schedule an authorized service provider to repair the chair in the consumer's residence.
- Parts - All parts deemed necessary for repairs will be shipped to the consumer at no charge by the OGAWA service department.

## CONSUMER WARRANTY LIMITATIONS AND EXCLUSIONS

- Warranties are only valid in the 48 contiguous United States and Canada and are contingent upon the consumer operating the chair according to the corresponding instruction manual.
  - The warranty only applies to OGAWA products and does not include any accessories or enhancements.
  - Field service requires pre-approval and must be performed by OGAWA's authorized field service personnel. Field service is only available in the United States and in major metropolitan areas in Canada.
  - Softening of foams and filling composites in pillows, pads, and memory foam occurs naturally and does not constitute a defect under this warranty.
  - Fading, wear and piling of fabrics occurs naturally and does not constitute a defect under this warranty.
  - Natural markings, grain and dye variations in leather do not constitute a defect under this warranty.
  - Warranties do not cover any loss or damage resulting from improper installation, unauthorized repairs or modifications, improper use of electrical/power supply, loss of power, dropped product, a malfunction or damage of an operating part from failure to provide manufacturer's recommended maintenance, transportation damage, theft, abuse, misuse, neglect, vandalism or environmental conditions (fire, floods, rust, corrosion, sand, dirt, windstorm, hail, earthquake or exposure to weather conditions), loss of use during the period the product is at a repair facility, or otherwise awaiting parts or repair.
  - Damage due to shipping and handling does not constitute a defect under this warranty.
  - Under no circumstance shall OGAWA or its representatives be liable for indirect, consequential, or incidental damages (including damages for lost profits, business interruption, bodily injury, medical and the like), even if any party has been advised of the possibility of such damages.
  - Warranties are non-transferable and shall be in lieu of any other warranty, express or implied, including but not limited to any implied warranty or merchantability or fitness for particular use.
  - OGAWA's sole liability and the purchaser's exclusive remedy shall be for the repair, or at OGAWA's option, for the replacement of the defective part.  
Notwithstanding the above, if replacements parts for defective materials are not available, OGAWA reserves the right to make substitutions in lieu of repair or replacement.
- All warranties begin on the DATE OF PURCHASE; no allowance or extension is offered for delivery and/or installation.
  - Warranties do not apply to rental, business, commercial, institutional or other non-residential users.



**OGAWA**

861 S. Oak Park Road,  
Covina, CA 91724

TEL: 844-438-6429  
support@ogawaworldusa.com

[www.ogawaworldusa.com](http://www.ogawaworldusa.com)